



■ P R O D U C T C A T A L O G ■



## Providing Global Power Quality Solutions

It is a global economy, that is why POWERVAR manufactures power quality solutions for North American and International electronic equipment. Getting conditioned, quality power is not strictly a North American challenge. Globally, the quality of electrical power can vary dramatically from place to place. Every piece of electronic equipment in the world works better and more dependably when it is protected from spikes, blackouts, electrical noise, common mode voltage and other power protection challenges. That is why POWERVAR designs and manufactures a complete line of power quality solutions to be used around the world.



POWERVAR provides power protection solutions you can rely on ... every hour of every day ... everywhere ... *with confidence*. Your sensitive electronic systems are hanging out there . . . open and vulnerable to nearly every kind of power problem man and nature can throw at them. This product guide provides information to help you select effective protection for your microprocessor-based electronic equipment. It shows the complete lineup of POWERVAR products including features, specifications and product selection assistance.

**Welcome to POWERVAR**, offering real solutions and quality protection for your critical technology.

### POWERVAR Sales Philosophy

The POWERVAR technical sales team is dedicated to solving power quality problems before and after they occur. Proactive and professional with global capabilities – these experts at POWERVAR offer unmatched Solutions for Power Quality.

## Solutions for Power Quality®

Avoid all of the unnecessary costs	4-5
The 3 D's of Power Quality	6
The ABCs of Power Conditioning	7
Power Viruses	8-9
We have the right solution	10-11
Standard Power Conditioners	12-13
Ground Guard Power Conditioners	14-15
Medical Power Conditioners	16-17
Hardwired Power Conditioners	18-19
Single-Phase Power Conditioner	20-21
Global Power Interface (GPI) Power Conditioners	22-27
CX Series Power Conditioners	28-29
Security One UPMs	30-39
Security Plus Series UPS	40-41
Local Area Power Center (LAPC)	42-43
3200 Series Three-Phase UPS	44-45
ONePlus™ Series UPS	45-46
ON Series	47-48
Sinergy S II Series UPS	49-50
Corporate information	51-52

## Avoid all of the unnecessary costs — financial and otherwise — of equipment downtime.

Whatever your business or profession may be, equipment which crashes can cause real problems for your entire operation. Damaged or compromised components, disrupted processes, lack of reliability . . . they all add up to frustration, broken schedules and costly downtime. The problem is caused by a host of power disturbances – some visible and many invisible - that threaten your equipment’s operation every year.

Power “disturbances” are simply those large and small variations in the quality of the electric power you use day in and day out. Disturbances can come from your local utility company, but most are created within your own facility as a result of the distribution and use of electrical power. These variations include high-energy voltage transients, sags and swells, electrical noise, and common-mode voltage, as well as the power outages everyone witnesses when the lights go out. The vast majority of these disturbances are likely to be unnoticeable, that is, until you have to deal with the expensive consequences.

### What is wrong with electrical power?

The average, well-managed electrical supply system in North America experiences about 8.8 hours of power outages annually.

But like an iceberg, it is what you do not see that usually causes the most damage. While power outages are the visible part of the threat, there are other types of power disturbances which you cannot see. These disturbances are hazardous to equipment which requires clean, quality power in order to perform at peak efficiency.

The more sophisticated your equipment, the more vulnerable it is to damage from power quality problems. Around the world, research shows power disturbances are prevalent everywhere there is electricity.

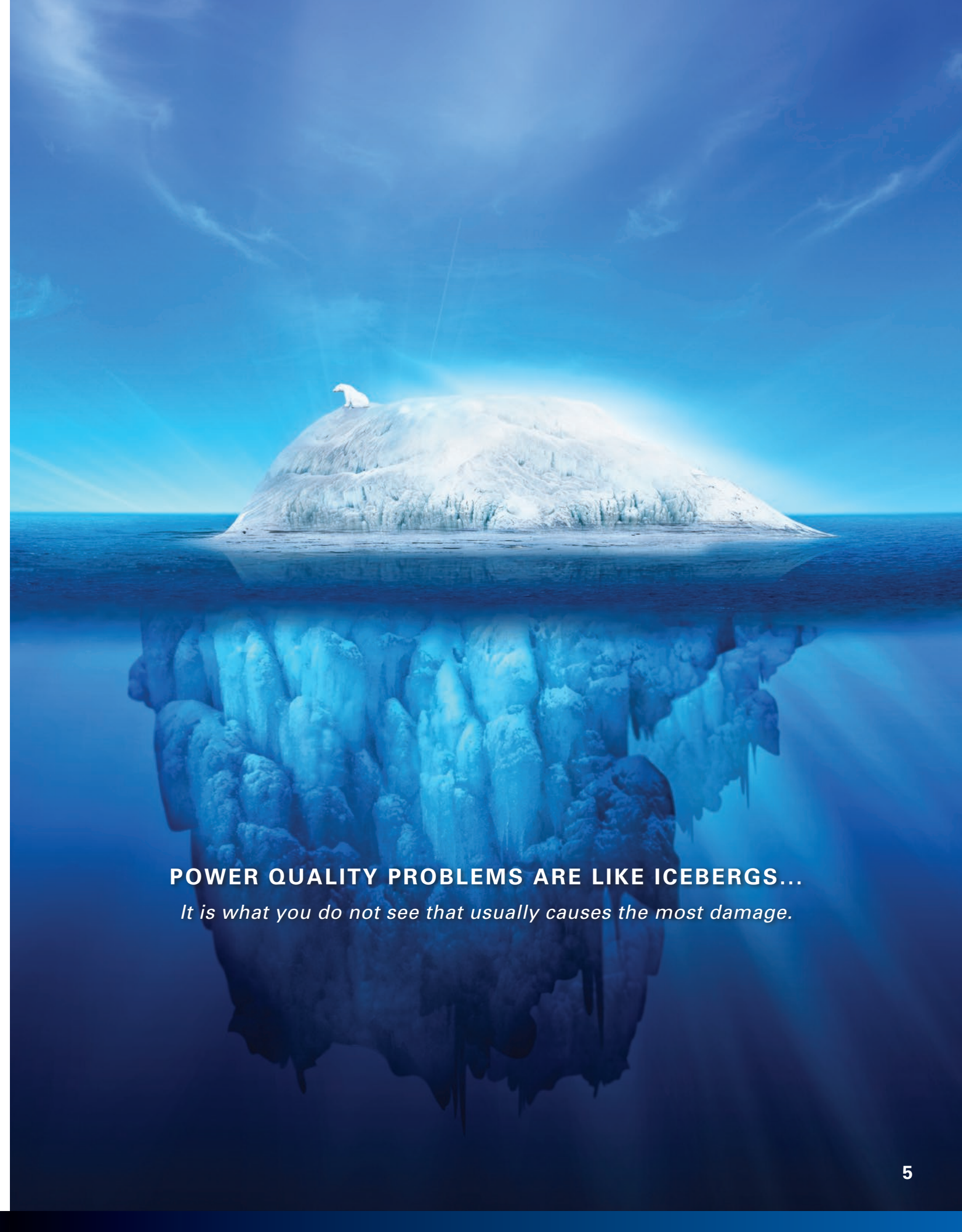

**POWER QUALITY PROBLEMS ARE LIKE ICEBERGS...**

*It is what you do not see that usually causes the most damage.*

# The 3 D's of Power Quality

There are three ways that power quality problems affect sensitive microprocessor-based equipment. They are called the "3 D's" – Destruction, Degradation, and Disruption. The 3 D's are warning signs that your system is experiencing power quality problems.

**Destruction** occurs when a power disturbance is so large that its energy literally "blows up" or destroys a semiconductor device like a transistor or integrated circuit. Destructive power disturbances are the easiest to identify since they leave visible evidence of their occurrence – smoke, soot and charred components. Establishing cause and effect is easy with destructive events.

**Degradation** occurs when lower amplitude power disturbances enter an electronic system and affect a semiconductor at a microscopic level. Solid-state junctions are designed to operate at small voltages. Degrading power disturbances often exceed the voltage tolerances of the component. Erosion of the semiconductor material occurs (much like rust damages metal), leaving less of the semiconductor material to handle the current needs of the circuit. Higher operating temperatures are the result. Damage from degrading events tends to be cumulative. Eventually so much damage occurs that the semiconductor junction experiences "thermal runaway" and fails. Establishing cause and effect may be difficult or impossible since there are not any visible failure indications.

**Disruption** occurs from power disturbances that are of such a frequency and amplitude that they can mimic actual logic signals, causing the digital system to make incorrect decisions. Disruption also occurs when neutral to ground (common mode) voltages become excessive. Disruptive events are difficult to document and may be easily mistaken for software "bugs" or operator errors. Disruptive events are the most common cause of system lockups and "No Trouble Found" service calls.

**Whatever your problem, whatever your system . . .** POWERVAR has the answers you can depend on to prevent power quality problems.

# The ABCs of Power Conditioning

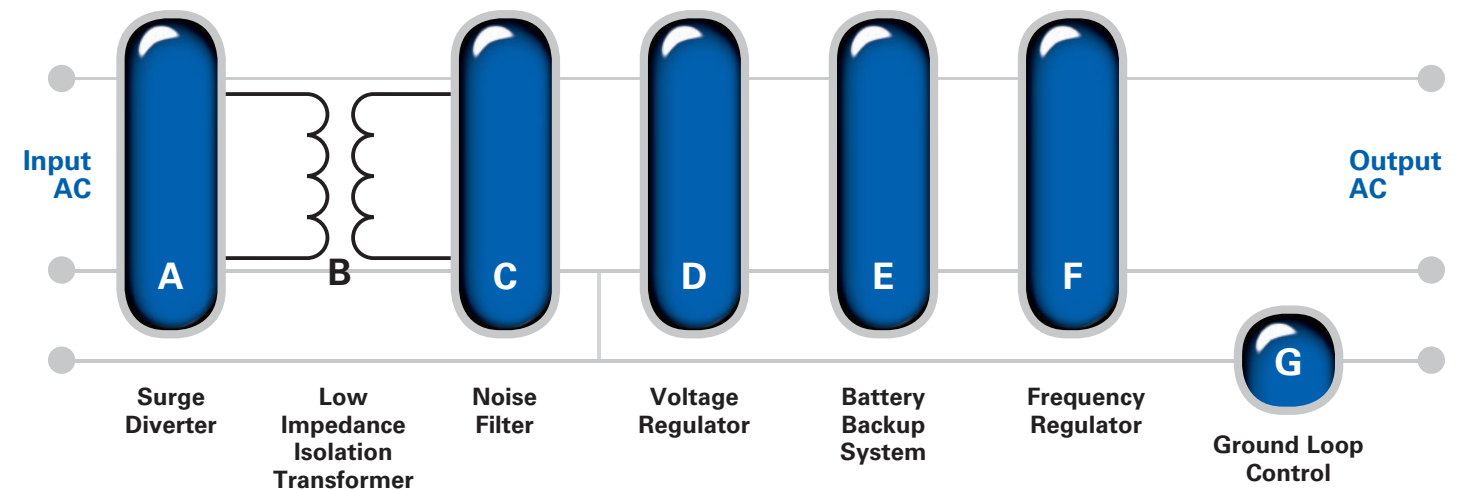

## Think you are protected? *Let's really see . . .*

**Surge diverters, filters and ordinary UPS systems are only partially effective.**

In 1986, POWERVAR created The ABCs of Power Conditioning as a way of explaining the seven basic power protection elements used to build an effective power quality solution. These building blocks are available to every power protection manufacturer – yet most manufacturers choose to include only one or two of the building blocks in their product. At best that means your system and your business are only partially protected.

You should not have to wonder which protection building blocks are in the power protection solution you are considering. That is why POWERVAR products include the ABCs as part of our model number nomenclature. You will never be in the dark about what type of protection you have selected.







The solution is power conditioning from POWERVAR. That is how you protect your valuable equipment – and your business operation – from power outages and unseen power disturbances.

## The ABCs of Power Conditioning

In many respects, power problems are like a biological virus. They enter your electronic equipment unseen. By the time you become aware of them, the damage has already been done. And like a virus, prevention of power problems is preferable to curing them after they have done their dirty work.

**Let's examine the different power quality disturbances or viruses, and which of elements of the ABCs are used to combat each.**

# Power Viruses

-  **HIGH-VOLTAGE SURGES** — Power surges can send your expensive computers and other electronic equipment to the dumpster. Surges can contain substantial amounts of energy, causing outright catastrophic component failure. Some surges contain smaller energy levels that erode components microscopically, leaving them in a weakened state. Surges are addressed with a surge diverter (A) — a device that diverts excessive voltages away from the system by shunting them to ground. Although the surge diverter protects against these major power surges, transient voltages smaller than 250–300 volts usually slip by the surge diverter, causing equipment to be exposed to degrading energy spikes over the long term.
-  **COMMON-MODE VOLTAGE** — Surge diverters (as well as noise filters) shunt disturbance energy to ground, resulting in a neutral-to-ground (common-mode) voltage — a situation that's highly disruptive to digital and microprocessor-based technologies. The low-impedance isolation transformer (B) provides a mechanism for bonding the electrical neutral to the ground in a way that is acceptable to electrical codes. This enhances the operation of surge diverters and noise filters because the transformer bond prevents the formation of neutral to ground voltage. The isolation transformer also acts as an excellent “cushion” against power disturbances in general.
-  **ELECTRICAL NOISE** — Power line noise filters (C) address the disturbances that slip by the surge diverter along with the low-amplitude, high-frequency noise that the surge diverter is not designed to handle. Typically these disturbances are caused by nearby electrical “neighbors” such as lighting ballasts, appliances, motors, electrical HVAC controls, and even other computer power supplies. Not only can noise wear away electronic components, it can also interfere with the reliable operation of digital circuits. Like surge diverters, noise filters shunt power disturbances to ground.
-  **VOLTAGE SWELLS AND SAGS** — Swells and sags can originate outside of a facility but can also be created by equipment used inside the facility. For some electronic equipment with older, linear power supply technology, well-regulated voltage is critical to proper performance. Fortunately, most equipment uses newer-style switched mode power supplies, which are largely immune to voltage irregularities. The need for voltage regulation is infrequent, but when necessary, voltage swells and sags are eliminated with a voltage regulator (D). Various regulation technologies are available, and careful consideration is necessary to select the one that's best suited for the application.
-  **POWER OUTAGES** — If power outages are the problem, an uninterruptible power supply [UPS] (E) will be the answer. A UPS converts DC energy stored in batteries into AC energy to power the electronic load temporarily. All UPS products are not equal. Some UPS products are online and others are standby, and some have true sine wave outputs and others have square wave or modified square wave outputs. Some units provide power conditioning and most do not. POWERVAR UPM products provide conditioned, sine wave, AC power — the kind your equipment was designed to use.
-  **UNSTABLE AC FREQUENCY** — AC power in North America is generated at a frequency of 60 Hz, while in Europe and many other locales, AC power is generated at 50 Hz. In developing countries, or where power is sourced from an electrical generator, the frequency may not always be stable. In such cases, a frequency regulator (F) is required. An online UPS or AC inverter is one answer for ensuring stable-frequency AC power for predictable equipment performance.
-  **GROUND LOOPS** — When electronic systems are connected into a network, multiple branch electrical circuits are involved in powering the various network components. Along with these different circuits come different safety ground impedances. The result is the formation of “ground loops” in which noise currents flow in the loops created by the grounding and shielding conductors of the signal cables used to connect the network. These loop currents cause communication errors and data packet collisions. Large loop currents will easily destroy the communication drivers on interface cards. For many years, the only solution for addressing ground loop issues was the dedicated-isolated electrical circuit. POWERVAR's Ground Guard technology (G) is highly effective in preventing the formation of ground loops and eliminating the need for special dedicated-isolated electrical circuits.



## Whatever your problem, whatever your system... We have the right solution

Power viruses are contracted the same way as other viruses. They are passed along – often by your system's electrical neighbors within your facility – factory, printing plant, hospital laboratory, or retail establishment – almost every “electrical neighbor” contributes to troublesome power pollution. Fluorescent lighting ballasts, electric motors, elevators, electronic controls for HVAC equipment and computer power supplies can create electrical disturbances that not only affect immediate performance, but also in the longer term can damage components within electronic equipment.

The only method to eliminate these power viruses is by implementing a solution which contains an isolation transformer, surge diverter, and noise filter, hence the ABCs of Power Conditioning.



## We are the replacement for the electrician

If you are specifying dedicated-isolated electrical circuits for your system installations, you are setting up your customer and yourself for the mess associated with the installation of electrical wiring – not to mention the delays of waiting for the electrical contractor and the challenge of ensuring that the wiring is installed according to specification. POWERVAR's Ground Guard technology is field-proven to eliminate the need for dedicated-isolated electrical wiring, and in the process, provide flexibility, cost savings and greater reliability for the installation.

## POWERVAR *Power Conditioners* and *Uninterruptible Power Managers* are available in a variety of *sizes, models and connections*

All of our power quality solutions provide the cleanest available power for your sensitive equipment. That is because every POWERVAR Power Conditioner and Uninterruptible Power Manager (UPM) combines surge diversion and noise filtering with a highly efficient low-impedance isolation transformer. With sizes from 78 VA single-phase to 300 kVA three-phase and a variety of connection styles, you can get precisely the right power quality solution for your equipment - whether it is a Point-of-Sale system, a scientific instrument, a semiconductor tool, or a multicolor digital printing press.

For example, there are special safety concerns for hospital equipment used in the vicinity of a patient. Safety regulations UL60601-1 and IEC60601 are designed to ensure that these special safety concerns are met. When patient safety and power quality are both important, our Medical Power Conditioners and UPMs are all listed to the requirements of UL60601-1 and IEC60601, and each has less than 300  $\mu$ amps of leakage current. Hospital-grade plugs and receptacles are included on North American medical models. Our International Medical Power Conditioners are also available in a version with an isolated output (floating) secondary.

A medical facility's focus is on providing superior care to their patients. But, when the most basic care - accurate data, basic communications, or reliable equipment - is compromised by poor quality power, patient's lives are at risk. Our Mobile Power Manager (MPM) simultaneously powers connected equipment while recharging batteries. Existing non-powered carts can be upgraded at an affordable cost. PC-based client software and server based fleet management software is available to administer your mobile application.

Concerned about SEMI-S2? You do not need to be since POWERVAR's GPI Series 2000 three-phase Power Conditioners are available with SEMI-S2 certification. You can provide reliable conditioned power for semiconductor fabrication processes with the assurance that your power conditioning solution meets all the safety recommendations of SEMI-S2.

We also offer power quality solutions tailored to meet the specific needs of retail, mobile and industrial applications.



## Consultative Solutions

POWERVAR Power Specialists have the education, training and know-how acquired through experience that enables them to identify your system's specific needs . . . and the best way to fulfill them. The diagnostic process starts at your location, where we conduct a thorough examination of your application, complete with power probes and oscilloscopes, to examine the quality of the electrical service powering your equipment.

Your POWERVAR specialist will ask numerous questions designed to help pinpoint any problems you have been experiencing, and the causes. Once we have the full picture of your situation, we can prescribe precisely the kind of protection your equipment needs.

Do not settle for less-than-satisfactory "solutions" that leave you vulnerable to common power quality problems . . . or "one size fits all" equipment from companies that have neither the knowledge nor the breadth of products to develop a system that meets your needs precisely.

***Talk to a POWERVAR Power Specialist today . . .*** and start enjoying all of the benefits of clean, reliable power. Our telephone numbers are listed on the back cover of this guide.

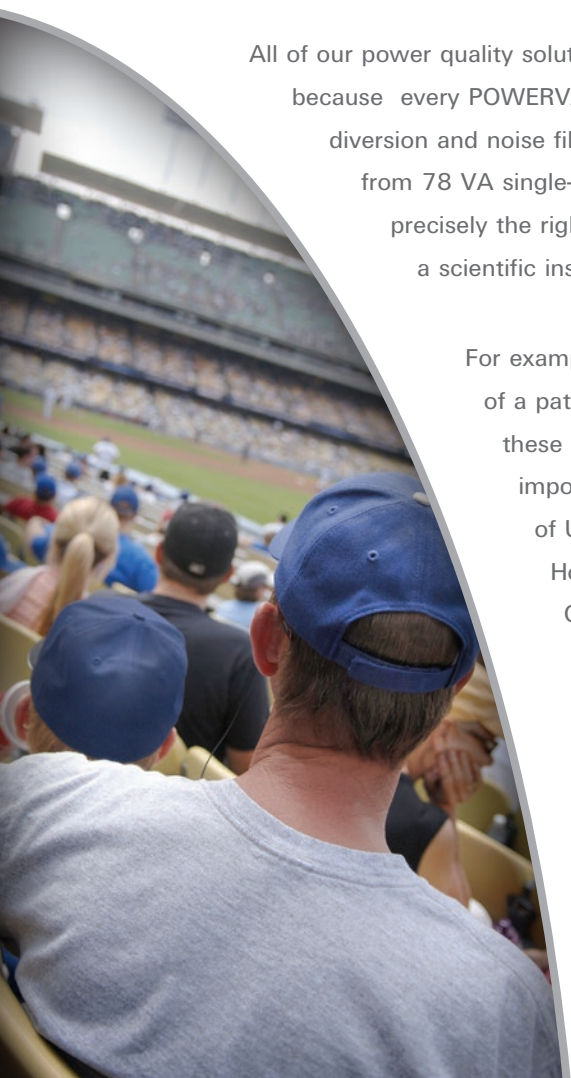

# POWERVAR Standard Power Conditioners



For use with any microprocessor-based electronic equipment.

POWERVAR Standard Power Conditioners incorporate a low impedance isolation transformer, as well as a surge diverter and power line filter to eliminate noise, spikes and transients before they have a chance to wreak havoc on your equipment.

You can trust these power conditioners to protect your sensitive equipment from the biggest problem computers face; common-mode voltage. Common-mode voltage can cause everything from equipment lockups to data losses to "No Trouble Found" service calls.

All North American models have UL and cUL listings. International models are safety-agency listed and carry the CE mark.

- Product sizes range from 78 VA to 2500 VA
- Suitable for use with instrumentation, analyzers, Point-of-Sale (POS) systems, ATMs, security systems, etc.
- Prevents hardware destruction, component degradation and operational disruption
- Red flashing LED (amber for international models) warns if the AC outlet is missing its input safety ground
- Let through voltage is less than 10 volts normal mode and less than 0.5 volts neutral-to-ground when tested to ANSI/IEEE C62.41
- POWERVAR's five-year warranty on parts and labor provides complete peace of mind

North American	Load Current (Amps)	Load Power (VA)	Input Voltage (VAC)	Output Voltage (VAC)	Frequency (Hz)	Case Size	Ship Weight (lb)
ABC065-11	.65	78	120	120	60	A	5
ABC100-11	1.0	120	120	120	60	A	6
ABC150-11	1.5	180	120	120	60	A	6
ABC152-11	1.5	180	120	120	60	B	8
ABC201-11	2.0	240	120	120	60	A	7
ABC202-11	2.0	240	120	120	60	B	9
ABC302-11	3.0	360	120	120	60	B	11
ABC402-11	4.0	480	120	120	60	B	12
ABC400-11	4.0	480	120	120	60	C	16
ABC500-11	5.0	600	120	120	60	C	18
ABC600-11	6.0	720	120	120	60	C	20
ABC700-11	7.0	840	120	120	60	C	22
ABC830-11	8.3	1000	120	120	60	D	34
ABC1000-11	10.0	1200	120	120	60	D	38
ABC1200-11	12.0	1440	120	120	60	D	43
ABC1600-11	16.0	1920	120	120	60	D	52
ABC2000-11	20.0	2400	120	120	60	D	63

International	Load Current (Amps)	Load Power (VA)	Input Voltage (VAC)	Output Voltage (VAC)	Frequency (Hz)	Case Size	Ship Weight (kg)
ABC150-22INT	.65	150	230	230	50/60	A	5
ABC250-22INT	1.1	250	230	230	50/60	B	5
ABC500-22INT	2.1	500	230	230	50/60	C	9
ABC750-22INT	3.1	750	230	230	50/60	C	10
ABC1000-22INT	4.2	1000	230	230	50/60	D	17
ABC1250-22INT	5.1	1250	230	230	50/60	D	18
ABC1500-22INT	6.3	1500	230	230	50/60	D	20
ABC2000-22INT	8.3	2000	230	230	50/60	D	23
ABC2500-22INT	10.4	2500	230	230	50/60	D	28

**Case Dimensions** (H x W x D) - in. (mm.):  
 A Case - 3.61 x 4.25 x 6.74 (92 X 108 X 171)  
 B Case - 4.23 x 4.97 x 7.58 (107 x 126 x 193)  
 C Case - 4.29 x 8.10 x 11.80 (109 x 206 x 300)  
 D Case - 5.60 x 11.15 x 16.10 (142 x 283 x 409)

**Wall Mount Option:**  
 Available on all models.

# POWERVAR

## Ground Guard Power Conditioners



Engineered to satisfy demanding Point-of-Sale applications.

POWERVAR Ground Guard Power Conditioners incorporate a low impedance isolation transformer, which provide networked systems with benefits beyond those of traditional power conditioning products. Filter elements in the safety ground circuit prevents the formation of "ground loops," which are common in networked applications.

This "ground conditioning" feature combined with a high energy surge diverter and a power line filter completely eliminates the need for both dedicated electrical circuits and isolated ground wiring.

All North American models have UL and cUL listings. International models are safety-agency listed and carry the CE mark.

- Product sizes range from 78 VA to 2500 VA
- Safeguards POS systems in restaurants, hotels and retail/convenient stores
- Ground Guard conditioning circuitry eliminates ground loops
- Red LED (amber for international models) flashes if AC outlet is missing its input safety ground
- Prevents hardware destruction, component degradation, and operational disruption
- Let through voltage is less than 10 volts normal mode and less than 0.5 volts neutral-to-ground when tested to ANSI/IEEE C62.41
- POWERVAR's five-year warranty on parts and labor provides complete peace of mind

North American	Load Current (Amps)	Load Power (VA)	Input Voltage (VAC)	Output Voltage (VAC)	Frequency (Hz)	Case Size	Ship Weight (lb)
ABCG065-11	.65	78	120	120	60	B	5
ABCG100-11	1.0	120	120	120	60	B	7
ABCG152-11	1.5	180	120	120	60	B	8
ABCG202-11	2.0	240	120	120	60	B	9
ABCG302-11	3.0	360	120	120	60	B	11
ABCG402-11	4.0	480	120	120	60	B	12
ABCG400-11	4.0	480	120	120	60	C	16
ABCG500-11	5.0	600	120	120	60	C	18
ABCG600-11	6.0	720	120	120	60	C	20
ABCG700-11	7.0	840	120	120	60	C	22
ABCG830-11	8.3	1000	120	120	60	D	34
ABCG1000-11	10.0	1200	120	120	60	D	38
ABCG1200-11	12.0	1440	120	120	60	D	43
ABCG1600-11	16.0	1920	120	120	60	D	52
ABCG2000-11	20.0	2400	120	120	60	D	63

International	Load Current (Amps)	Load Power (VA)	Input Voltage (VAC)	Output Voltage (VAC)	Frequency (Hz)	Case Size	Ship Weight (kg)
ABCG150-22INT	.65	150	230	230	50/60	B	3.5
ABCG250-22INT	1.1	250	230	230	50/60	B	4.5
ABCG500-22INT	2.1	500	230	230	50/60	C	7.5
ABCG750-22INT	3.1	750	230	230	50/60	C	8.5
ABCG1000-22INT	4.2	1000	230	230	50/60	D	16.5
ABCG1250-22INT	5.1	1250	230	230	50/60	D	17.5
ABCG1500-22INT	6.3	1500	230	230	50/60	D	18.5
ABCG2000-22INT	8.3	2000	230	230	50/60	D	22.5
ABCG2500-22INT	10.4	2500	230	230	50/60	D	23.5

**Case Dimensions** (H x W x D) - in. (mm.):  
 B Case - 4.23 x 4.97 x 7.58 (107 x 126 x 193)  
 C Case - 4.29 x 8.10 x 11.80 (109 x 206 x 300)  
 D Case - 5.60 x 11.15 x 16.10 (142 x 283 x 409)

**Wall Mount Option:**  
 Available on all models.



# POWERVER Medical Power Conditioners



For use with microprocessor-based medical equipment requiring conformance with UL60601 and IEC60601.

POWERVER Medical Power Conditioners incorporate a low impedance isolation transformer, as well as a surge diverter and power line filter to eliminate noise, spikes and transients before they have a chance to damage your instrument.

Medical instruments have special power protection needs. Systems such as patient monitors, imaging equipment and various computer systems used within the "patient vicinity" require special safety precautions and POWERVER conditioners are the perfect prescription. POWERVER Medical Power Conditioners not only protect systems used for patient care, they are also built to meet the safety requirements of IEC60601 and deliver clean, conditioned power.

- Product sizes range from 78 VA to 2500 VA
- Suitable for protecting computers, analyzers, instrumentation and patient monitors
- North American models are UL and cUL listed, UL60601-1 3RD Ed. and CSA22.2 No. 60601
- International models are IEC60601-1 3RD Ed. listed and CE marked
- Let through voltage is less than 10 volts normal mode and less than 0.5 volts neutral-to-ground when tested to ANSI/IEEE C62.41
- For patient safety, leakage current is less than 300  $\mu$ A
- Red LED (amber for international models) warns if the hospital's AC outlet is missing its safety ground
- All plugs and receptacles are hospital grade (North American)
- These power conditioners are backed by our five-year parts and labor warranty

North American	Load Current (Amps)	Load Power (VA)	Input Voltage (VAC)	Output Voltage (VAC)	Frequency (Hz)	Case Size	Ship Weight (lb)
ABC200-11MED	2.0	240	120	120	60	C	18
ABC300-11MED	3.0	360	120	120	60	C	18
ABC400-11MED	4.0	480	120	120	60	C	23
ABC500-11MED	5.0	600	120	120	60	C	23
ABC600-11MED	6.0	720	120	120	60	C	23
ABC700-11MED	7.0	840	120	120	60	D	38
ABC830-11MED	8.3	1000	120	120	60	D	38
ABC1000-11MED	10.0	1200	120	120	60	D	43
ABC1200-11MED	12.0	1440	120	120	60	D	51
ABC1600-11MED	16.0	1920	120	120	60	D	62

International	Load Current (Amps)	Load Power (VA)	Input Voltage (VAC)	Output Voltage (VAC)	Frequency (Hz)	Case Size	Ship Weight (kg)
ABC500-22MED	2.1	500	230	230	50/60	C	11
ABC750-22MED	3.1	750	230	230	50/60	C	13
ABC1000-22MED	4.2	1000	230	230	50/60	D	17
ABC1250-22MED	5.1	1250	230	230	50/60	D	18
ABC1500-22MED	6.3	1500	230	230	50/60	D	20
ABC2000-22MED	8.3	2000	230	230	50/60	D	23
ABC2500-22MED	10.4	2500	230	230	50/60	D	28

**Case Dimensions** (H x W x D) - in. (mm.):  
 C Case - 4.29 x 8.10 x 11.80 (109 x 206 x 300)  
 D Case - 5.60 x 11.15 x 16.10 (142 x 283 x 409)

**Wall Mount Option:**  
 Available on all models.

# POWERVAR

## Hardwired Power Conditioners



For electronic systems operating in a manufacturing or industrial environment.

If your system includes programmable logical controllers (PLCs), computers, CNC systems, robotics, acquisition systems, or other sensitive electronic equipment in locations where they can be affected by noise from nearby relays, drives, or motors, then you need industrial-strength protection from power problems. POWERVAR Hardwired Power Conditioners are just the solutions. All have UL and cUL listings.

Even under the most demanding factory-floor conditions, these models provide the clean, conditioned power that your equipment needs for trouble free operation. Which translates into less downtime, higher productivity and a rapid payback on your investment. Each conditioner combines a surge diverter, isolation transformer and power line filter, to effectively eliminate the whole range of power quality viruses.

- Product sizes range from 180 VA to 1440 VA
- Designed for harsh industrial applications
- All models provide clean, conditioned 120 VAC power
- Prevents hardware destruction, component degradation and operational disruption
- Let through voltage is less than 10 volts normal mode and less than 0.5 volts neutral-to-ground when tested to ANSI/IEEE C62.41
- Backed by POWERVAR's five-year warranty on parts and labor

North American	Load Current (Amps)	Load Power (VA)	Input Voltage (VA)	Output Voltage (VA)	Frequency (Hz)	Case Size	Ship Weight (lb)
<b>ABC150-11HW</b>	1.5	180	120	120	60	A	9
<b>ABC200-11HW</b>	2.0	240	120	120	60	A	10
<b>ABC300-11HW</b>	3.0	360	120	120	60	A	12
<b>ABC500-11HW</b>	5.0	600	120	120	60	A	15
<b>ABC700-11HW</b>	7.0	840	120	120	60	B	25
<b>ABC1000-11HW</b>	10.0	1200	120	120	60	B	38
<b>ABC1200-11HW</b>	12.0	1440	120	120	60	B	43

**Case Dimensions** (H x W x D) - in.:

A Case - 4.67 x 6.67 x 9.00  
 B Case - 14.15 x 6.25 x 16.5

# POWERVAR

## Single-Phase Power Conditioners



For use with large power loads or those applications with dual-voltage requirements.

If you have small or mid-range computer systems, multiple network servers, large phone systems, or other critical equipment which requires more power, POWERVAR Single-Phase Power Conditioners can save you time and frustration.

Whether the electrical noise is generated on the line or by the load, thanks to the low impedance isolation transformer this conditioner protects your system from all the problems caused by power disturbances, ranging from lost data to "No Trouble Found" service calls.

All models have UL and cUL listings.

- Product sizes range from 2 kVA to 9.6 kVA
- Systems provide clean power at 120, 208 or 240 VAC for loads up to 40 amps
- Let through voltage is less than 10 volts normal mode and less than 0.5 volts neutral-to-ground when tested to ANSI/IEEE C62.41
- Dual-output models can simultaneously protect both high-voltage and low-voltage systems at a less expensive cost and effort than installing two separate conditioners
- Hardwired and plug/receptacle models are available
- All models include POWERVAR's five-year warranty on parts and labor

North American	Load Current (Amps)	Load Power (kVA)	Input Voltage (VA)	Output Voltage (VA)	Frequency (Hz)	Case Size	Ship Weight (lb)
ABC2000-2S	8.33**	2.0	208/240	120/240	60	A	73
ABC2030-2S*	8.33**	2.0	208/240	120/240	60	A	71
ABC3000-11	24	2.8	120	120	60	A	85
ABC3030-11*	25	3.0	120	120	60	A	82
ABC3000-2S	12.5**	3.0	208/240	120/240	60	A	85
ABC3030-2S*	12.5**	3.0	208/240	120/240	60	A	83
ABC3300-33	15.8	3.3	208	208	60	A	94
ABC3800-11	31.7	3.8	120	120	60	A	98
ABC3830-11*	31.7	3.8	120	120	60	A	82
ABC3800-2S	15.8**	3.8	208/240	120/240	60	A	95
ABC3830-2S*	15.8**	3.8	208/240	120/240	60	A	91
ABC5000-2S	20.8**	5.0	208/240	120/240	60	A	121
ABC5000-33	23.5	5.0	208	208	60	A	117
ABC5030-2S*	20.8**	5.0	208/240	120/240	60	A	130
ABC5800-2S	24**	5.8	208/240	120/240	60	A	130
ABC6030-2S*	25**	6.0	208/240	120/240	60	A	130
ABC9600-2S*	10.0	9.6	208/240	120/240	60	B	175

\* hardwired connections.  
\*\* load amps per leg

#### Case Dimensions (H x W x D) - in.:

A Case - 10.00 x 12.47 x 18.00  
B Case - 18.00 x 17.00 x 25.00

# POWERVAR GPI Series B Power Conditioners

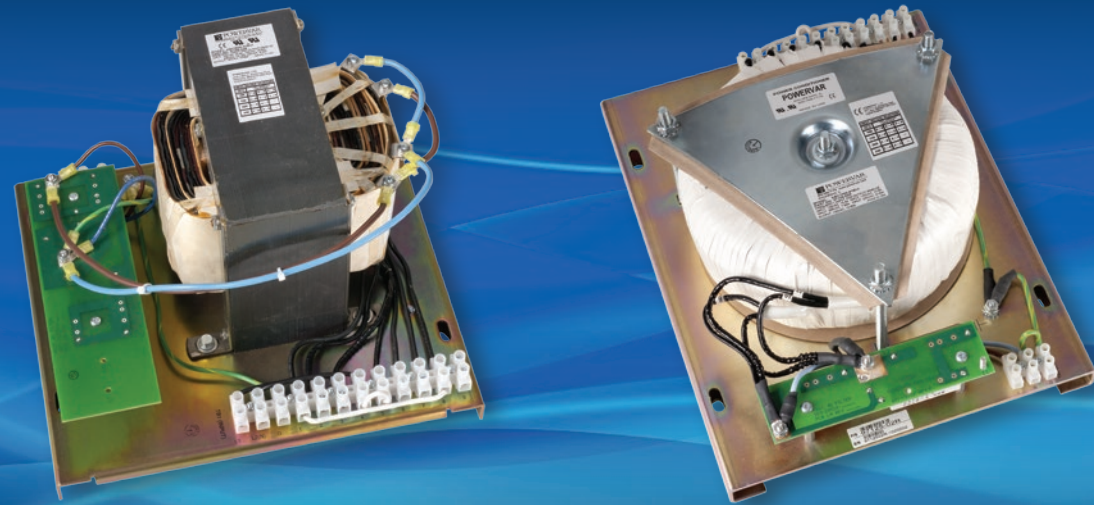

## For Original Equipment Manufacturers

The POWERVAR Global Power Interface (GPI) Series B Power Conditioners incorporate a low impedance isolation transformer, as well as a surge diverter and power line filter to eliminate noise, spikes and transients before they have a chance to damage your equipment. You can count on receiving clean, conditioned power with these power conditioners even when the quality of the local AC supply is unpredictable.

Clean power helps keep your equipment operating smoothly, which in turn reduces the number of service calls to remote locations. Wherever in the world you ship electronic and computer equipment, you'll save time, spare parts inventory and field service calls with our GPI Series B Power Conditioners. We have designed them specifically to be built into your equipment.

North American models have selectable input voltages of 100, 120, 208 or 240 volts with a fixed output of voltage of 120 volts. International models have selectable input voltages of 100, 120, 208, or 240 volts with a fixed output voltage of 240 volts. Your equipment can work with a range of international voltages without requiring several power supplies or other components.

All models are safety-agency listed and carry the CE mark.

- Product sizes range from 500 VA to 3000 VA
- Let through voltage is less than 10 volts normal mode and less than 0.5 volts neutral-to-ground when tested to ANSI/IEEE C62.41
- Accepts AC voltage inputs of 100, 120, 208 or 240 VAC, 50 or 60 Hz, and converts it to 120 VAC or 240 VAC
- Hardwired units designed to be built into OEM equipment
- Backed by POWERVAR's five-year warranty on parts and labor

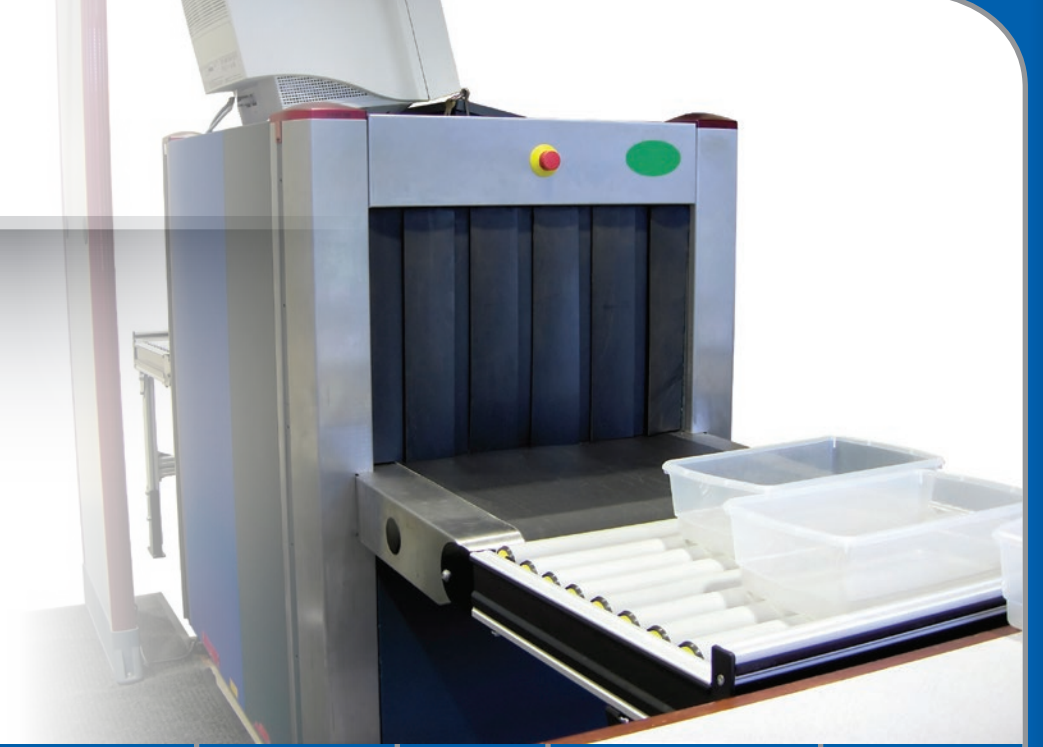

North American	Load Power (VA)	Input Voltage (VAC)	Output Voltage (VAC)	Frequency (Hz)	Mounting Dimensions (in)	Ship Weight (lb)
<b>ABC500-91BUI</b>	500	100/120/208/240	120	50/60	3.00 x 7.55 x 7.20	15
<b>ABC1000-91BUI</b>	1000	100/120/208/240	120	50/60	3.45 x 9.50 x 8.77	25
<b>ABC1500-91BUI</b>	1500	100/120/208/240	120	50/60	5.23 x 13.53 x 10.50	55
<b>ABC2000-91BUI</b>	2000	100/120/208/240	120	50/60	7.10 x 12.52 x 11.15	60
<b>ABC3000-91BUI</b>	3000	100/120/208/240	120	50/60	7.10 x 12.52 x 11.15	80

International	Load Power (VA)	Input Voltage (VAC)	Output Voltage (VAC)	Frequency (Hz)	Mounting Dimensions (mm)	Ship Weight (kg)
<b>ABC500-92BUI</b>	500	100/120/208/240	240	50/60	76 x 192 x 183	7.0
<b>ABC1000-92BUI</b>	1000	100/120/208/240	240	50/60	88 x 241 x 223	11.5
<b>ABC1500-92BUI</b>	1500	100/120/208/240	240	50/60	133 x 344 x 267	25.0
<b>ABC2000-92BUI</b>	2000	100/120/208/240	240	50/60	180 x 318 x 283	27.0
<b>ABC3000-92BUI</b>	3000	100/120/208/240	240	50/60	180 x 318 x 283	36.5

# POWERVAR GPI Series 1 Power Conditioners



The perfect choice for today's global original equipment manufacturers.

The POWERVAR Global Power Interface (GPI) Series 1 Power Conditioners incorporate a low impedance isolation transformer, as well as a surge diverter and power line filter to eliminate noise, spikes and transients before they have a chance to damage your equipment. You can count on receiving clean, conditioned power with these power conditioners even when the quality of the local AC supply is unpredictable.

Clean power helps keep your equipment operating smoothly, which in turn reduces the number of service calls to remote locations. Wherever in the world you ship electronic and computer equipment, you'll save time, spare parts inventory and field service calls with our GPI Series 1 Power Conditioners.

North American models have selectable input voltages of 100, 120, 208 or 240 volts with a fixed output of voltage of 120 volts. International models have selectable input voltages of 100, 120, 208, or 240 volts with a fixed output voltage of 240 volts. Your equipment can work with a range of international voltages without requiring several power supplies or other components. All models are safety-agency listed and carry the CE mark.

- Product sizes range from 500 VA to 3000 VA
- Let through voltage is less than 10 volts normal mode and less than 0.5 volts neutral-to-ground when tested to ANSI/IEEE C62.41
- Accepts AC voltage inputs, of 100, 120, 208 or 240 VAC, 50 or 60 Hz, and converts it to 120 VAC or 240 VAC
- NEMA-1 enclosure
- POWERVAR's five-year warranty on parts and labor provides complete peace of mind



North American	Load Power (VA)	Input Voltage (VAC)	Output Voltage (VAC)	Frequency (Hz)	Case Size	Ship Weight (lb)
ABC500-91	500	100/120/208/240	120	50/60	D	21
ABC1000-91	1000	100/120/208/240	120	50/60	D	34
ABC1500-91	1500	100/120/208/240	120	50/60	D	64
ABC2000-91	2000	100/120/208/240	120	50/60	E	67
ABC3000-91	3000	100/120/208/240	120	50/60	E	87

International	Load Power (VA)	Input Voltage (VAC)	Output Voltage (VAC)	Frequency (Hz)	Case Size	Ship Weight (kg)
ABC500-92	500	100/120/208/240	240	50/60	D	9.5
ABC1000-92	1000	100/120/208/240	240	50/60	D	15.4
ABC1500-92	1500	100/120/208/240	240	50/60	D	29.0
ABC2000-92	2000	100/120/208/240	240	50/60	E	30.4
ABC3000-92	3000	100/120/208/240	240	50/60	E	39.5

**Case Dimensions** (H x W x D) - in. (mm.):  
 D Case - 5.60 x 11.15 x 16.10 (142 x 283 x 409)  
 E Case - 7.60 x 11.36 x 12.73 (193 x 289 x 323)

# POWERVAR GPI Series 2000 Power Conditioners



## Protection for mission critical three-phase applications worldwide.

The GPI Series 2000 provides clean, noise-free power to three-phase electronic systems used in a range of industries.

The POWERVAR Global Power Interface (GPI) Series 2000 Power Conditioners incorporate a low impedance isolation transformer, as well as a surge diverter and power line filter to eliminate noise, spikes, and transients before they have a chance to wreak havoc on your equipment.

Standard equipment includes safety interlocks, emergency machine off (EMO), casters, and lockout/tagout breaker. GPI Series 2000 models with SEMI-S2 compliance are also available.

All North American models have UL and cUL listings. International models are safety-agency listed and carry the CE mark.

- Product sizes range from 10 kVA to 300 kVA
- For all applications worldwide - models available for both 50 and 60 Hz
- Voltage distribution and conditioning all in one solution
- EMO, safety interlocks, lockout/tagout breaker, and casters are standard on all models
- Optional SEMI-S2 compliant models
- Available options (depending on model) include input line cord, output receptacles, distribution panels, external EMO connector, basic power metering, and phase loss/low voltage detection and protection (when equipped with the power management package)
- Our five-year warranty on parts and labor provides complete peace of mind

North American	Load Power (VA)	Input Voltage (VAC)	Output Voltage (VAC)	Frequency (Hz)	Dimensions H x W x D (in)	Ship Weight (lb)
ABC10.0-XDXY	10	208/240/480/600 delta	208/120 wye	60	26 x 18 x 30	520
ABC15.0-XDXY	15	208/240/480/600 delta	208/120 wye	60	26 x 18 x 30	546
ABC20.0-XDXY	20	208/240/480/600 delta	208/120 wye	60	26 x 18 x 30	635
ABC25.0-XDXY	25	208/240/480/600 delta	208/120 wye	60	35 x 22 x 39	780
ABC30.0-XDXY	30	208/240/480/600 delta	208/120 wye	60	35 x 22 x 39	820
ABC35.0-XDXY	35	208/240/480/600 delta	208/120 wye	60	35 x 22 x 39	910
ABC45.0-XDXY	45	208/240/480/600 delta	208/120 wye	60	35 x 22 x 39	1120
ABC55.0-XDXY	55	208/240/480/600 delta	208/120 wye	60	47 x 22 x 39	1181
ABC65.0-XDXY	65	208/240/480/600 delta	208/120 wye	60	47 x 22 x 39	1250
ABC75.0-XDXY	75	208/240/480/600 delta	208/120 wye	60	47 x 22 x 39	1425
ABC85.0-XDXY	85	480/600 delta	480/277 wye	60	54 x 28 x 39	1445
ABC100.0-XDXY	100	480/600 delta	480/277 wye	60	54 x 28 x 39	1655
ABC125.0-XDXY	125	480/600 delta	480/277 wye	60	54 x 28 x 39	1765
ABC150.0-XDXY	150	480/600 delta	480/277 wye	60	54 x 28 x 39	1885
ABC175.0-XDXY	175	480/600 delta	480/277 wye	60	54 x 28 x 39	2090
ABC200.0-XDXY	200	480/600 delta	480/277 wye	60	64 x 28 x 39	2565
ABC230.0-XDXY	230	480/600 delta	480/277 wye	60	64 x 28 x 39	2815
ABC250.0-XDXY	250	480/600 delta	480/277 wye	60	74 x 56 x 39	3125
ABC300.0-XDXY	300	480/600 delta	480/277 wye	60	74 x 56 x 39	3350

International	Load Power (VA)	Input Voltage (VAC)	Output Voltage (VAC)	Frequency (Hz)	Dimensions H x W x D (mm)	Ship Weight (kg)
ABC10.0-4D4Y	10	400	400/230	50/60	660 x 457 x 762	272
ABC15.0-4D4Y	15	400	400/230	50/60	660 x 457 x 762	168
ABC20.0-4D4Y	20	400	400/230	50/60	660 x 457 x 762	305
ABC25.0-4D4Y	25	400	400/230	50/60	889 x 559 x 990	386
ABC30.0-4D4Y	30	400	400/230	50/60	889 x 559 x 990	408
ABC35.0-4D4Y	35	400	400/230	50/60	889 x 559 x 990	463
ABC45.0-4D4Y	45	400	400/230	50/60	889 x 559 x 990	505
ABC55.0-4D4Y	55	400	400/230	50/60	1194 x 559 x 990	608
ABC65.0-4D4Y	65	400	400/230	50/60	1194 x 559 x 990	646
ABC75.0-4D4Y	75	400	400/230	50/60	1194 x 559 x 990	687
ABC85.0-4D4Y	85	400	400/230	50/60	1372 x 711 x 990	733
ABC100.0-4D4Y	100	400	400/230	50/60	1372 x 711 x 990	841
ABC125.0-4D4Y	125	400	400/230	50/60	1372 x 711 x 990	922
ABC150.0-4D4Y	150	400	400/230	50/60	1372 x 711 x 990	989
ABC175.0-4D4Y	175	400	400/230	50/60	1372 x 711 x 990	1012
ABC200.0-4D4Y	200	400	400/230	50/60	1625 x 711 x 990	1355
ABC230.0-4D4Y	230	400	400/230	50/60	1625 x 711 x 990	1371
ABC250.0-4D4Y	250	400	400/230	50/60	1880 x 1422 x 990	1510
ABC300.0-4D4Y	300	400	400/230	50/60	1880 x 1422 x 990	1748

# POWERVAR CX Series Power Conditioners

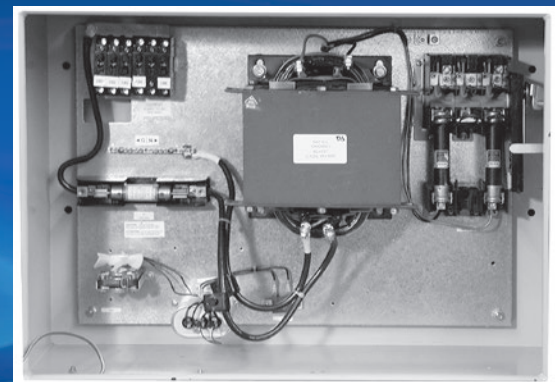

## Wall mount solution for industrial automation systems

POWERVAR CX Series low impedance power conditioners fulfill the requirements of industrial applications. The CX Series is optimized for the high pulsed current-on-demand required by switch mode power supplies without the need to oversize the VA rating. POWERVAR CX Series Power Conditioners require less space, generate less heat and improve stability to the load during peak currents.

Microprocessors within programmable logic controllers (PLCs) and industrial computers are forced to operate in harsh electrical environments. Reliable performance under these adverse conditions challenges industrial automation systems. POWERVAR power conditioners eliminate problems caused by power-line noise and completely isolate critical loads from electrical distribution systems — preventing disruption, degradation and destruction of critical circuitry.

- Product sizes range from 3600 VA to 9600 VA
- Designed for harsh industrial applications
- Let through voltage is less than 10 volts normal mode and less than 0.5 volts neutral-to-ground when tested to ANSI/IEEE C62.41
- All models have UL and cUL listings.
- POWERVAR's five-year warranty on parts and labor provides complete peace of mind

North American	Load Current (Amps)	Load Power (kVA)	Input Voltage (VAC)	Output Voltage (VAC)	Frequency (Hz)	Case Size	Ship Weight lb (kg)
<b>ABC3600-XX1</b>	30	3.6	240-480	120	60	A or B	A 130 (59) B 110 (20)
<b>ABC5000-XX1</b>	40	4.8	240-480	120	60	A or B	A 130 (59) B 110 (20)
<b>ABC9600-XX1</b>	80	9.6	240-480	120	60	C or D	A 250 (113) B 110 (104)

**Case Dimensions** (H x W x D) - in. (mm.):  
 A Case - 14 x 32 x 9 (356 x 813 x 229)  
 B Plate - 11 x 27 x 0.75 (279 x 686 x 19)  
 C Case - 22 x 32 x 12 (559 x 813 x 305)  
 D Plate - 19 x 27 x 0.75 (483 x 686 x 19)

# POWERVAR

## Security One Standard UPM

**POWERVAR UNINTERRUPTIBLE  
POWER MANAGER: WHAT A  
DIFFERENCE A LETTER MAKES.**



Prevents power disturbances from affecting the performance of mission critical devices

If you think a UPS is the ultimate in power protection, we've got some news for you: Our Security One UPM, or Uninterruptible Power Manager, performs functions your UPS never dreamed of.

Why settle for backup power alone when the POWERVAR Security One Standard UPM lets you manage the entire power interface? Thanks to its low impedance isolation transformer, this UPM delivers clean, fully conditioned power which is free from noise, voltage spikes and common-mode disturbances. If the power goes out, backup battery is one of the many benefits you will receive.

All North American models have UL and cUL listings. International models are safety-agency listed and carry the CE mark.

- Product sizes range from 420 VA to 3000 VA
- True sine-wave output
- Low impedance isolation transformer and line interactive operation
- User hot-swappable battery
- Meets FCC Class A (optional Class B available)
- Meets NEMA, FAA, and DOT guidelines for transportation of UPS batteries
- Let through voltage is less than 10 volts normal mode and less than 0.5 volts neutral-to-ground when tested to ANSI/IEEE C62.41
- POWERVAR's five-year warranty (two-year on batteries) on parts and labor provides complete peace of mind

North American	Load Current (Amps)	Load Power (VA)	Input Voltage (VAC)	Output Voltage (VAC)	Frequency (Hz)	Case Size	Ship Weight (lb)
ABCE420-11	3.5	420	120	120	60	B	32
ABCE600-11	5.0	600	120	120	60	C	41
ABCE800-11	6.7	800	120	120	60	C	47
ABCE1100-11	9.2	1100	120	120	60	D	73
ABCE1440-11	10.6	1440	120	120	60	D	79
ABCE2200-11	18	2160	120	120	50/60	E	160
ABCE3000-11	23	2760	120	120	50/60	E	165

International	Load Current (Amps)	Load Power (VA)	Input Voltage (VAC)	Output Voltage (VAC)	Frequency (Hz)	Case Size	Ship Weight (kg)
ABCE420-22	1.8	420	230	230	50/60	B	14.5
ABCE600-22	2.6	600	230	230	50/60	C	18.5
ABCE800-22	3.5	800	230	230	50/60	C	21.5
ABCE1100-22	4.8	1100	230	230	50/60	D	33.5
ABCE1440-22	6.3	1440	230	230	50/60	D	36.0
ABCE2200-22	9.57	2200	230	230	50/60	E	72.5
ABCE3000-22	13.0	3000	230	230	50/60	E	74.8

**Case Dimensions** (H x W x D) - in. (mm.):  
 B Case - 6.60 x 5.50 x 17.75 (168 x 140 x 451)  
 C Case - 8.00 x 5.80 x 17.50 (203 x 147 x 445)  
 D Case - 8.75 x 8.30 x 19.75 (222 x 211 x 502)  
 E Case - 19.25 x 8.26 x 22.00 (489 x 210 x 559)



**POWERVAR UNINTERRUPTIBLE  
POWER MANAGER: WHAT A  
DIFFERENCE A LETTER MAKES.**



Designed to be used with systems in  
a networked environment

Like the Security One Standard UPM, the Ground Guard UPM series provides complete conditioned and uninterruptible power for your networked systems. Our Ground Guard technology protects the performance of networked systems without the added expense and hassle of requiring dedicated isolated electrical circuits. Ground Guard prevents the occurrence of "ground loops" and makes dedicated-isolated electrical circuits obsolete. Enjoy faster installations, greater flexibility and cost savings with Ground Guard UPMs.

All North American models have UL and cUL listings. International models are safety-agency listed and carry the CE mark.

- Product sizes range from 420 VA to 1440 VA
- True sine-wave output
- Low impedance isolation transformer and line interactive operation
- User hot-swappable battery
- Meets NEMA, FAA, and DOT guidelines for transportation of UPS batteries
- Let through voltage is less than 10 volts normal mode and less than 0.5 volts neutral-to-ground when tested to ANSI/IEEE C62.41
- POWERVAR's five-year warranty (two-year on batteries) on parts and labor provides complete peace of mind

North American	Load Current (Amps)	Load Power (VA)	Input Voltage (VAC)	Output Voltage (VAC)	Frequency (Hz)	Case Size	Ship Weight (lb)
<b>ABCEG420-11</b>	3.5	420	120	120	60	B	33
<b>ABCEG600-11</b>	5.0	600	120	120	60	C	41
<b>ABCEG800-11</b>	6.7	800	120	120	60	C	47
<b>ABCEG1100-11</b>	9.2	1100	120	120	60	D	73
<b>ABCEG1440-11</b>	10.6	1440	120	120	60	D	79

International	Load Current (Amps)	Load Power (VA)	Input Voltage (VAC)	Output Voltage (VAC)	Frequency (Hz)	Case Size	Ship Weight (kg)
<b>ABCEG420-22</b>	1.8	420	230	230	50/60	B	15.0
<b>ABCEG600-22</b>	2.6	600	230	230	50/60	C	18.5
<b>ABCEG800-22</b>	3.5	800	230	230	50/60	C	21.5
<b>ABCEG1100-22</b>	4.8	1100	230	230	50/60	D	33.5
<b>ABCEG1440-22</b>	6.3	1440	230	230	50/60	D	36.0

**Case Dimensions** (H x W x D) - in. (mm.):  
 B Case - 6.60 x 5.50 x 17.75 (168 x 140 x 451)  
 C Case - 8.00 x 5.80 x 17.50 (203 x 147 x 445)  
 D Case - 8.75 x 8.30 x 19.75 (222 x 211 x 502)

# POWERVAR

## Security One Medical UPM

**POWERVAR UNINTERRUPTIBLE  
POWER MANAGER: WHAT A  
DIFFERENCE A LETTER MAKES.**



For use with microprocessor-based medical equipment requiring conformance with UL60601 and IEC60601.

If you think a UPS is the ultimate in power protections, we've got some news for you: Our Security One Medical UPM, or Uninterruptible Power Manager, performs functions your UPS never dreamed of.

For medical systems used in the vicinity of a patient (or anywhere that low leakage current is required), our medical UPMs are the perfect solution for providing conditioned, uninterruptible power.

North American models are listed to UL60601-1 and cUL22.2 No. 60601-1 and are suitable for patient vicinity applications. International models are listed to IEC60601-1 and are CE marked. All models reduce connected equipment leakage current to less than 300  $\mu$ amps.

- Product sizes range from 420 VA to 1440 VA
- True sine-wave output
- Low impedance isolation transformer and line interactive operation
- User hot-swappable battery
- Meets FCC Class A (optional Class B available)
- Meets NEMA, FAA, and DOT guidelines for transportation of UPS batteries
- Let through voltage is less than 10 volts normal mode and less than 0.5 volts neutral-to-ground when tested to ANSI/IEEE C62.41
- POWERVAR's five-year warranty (two-year on batteries) on parts and labor provides complete peace of mind



North American	Load Current (Amps)	Load Power (VA)	Input Voltage (VAC)	Output Voltage (VAC)	Frequency (Hz)	Case Size	Ship Weight (lb)
ABCE420-11IEC	3.5	420	120	120	60	B	32
ABCE600-11IEC	5.0	600	120	120	60	C	41
ABCE800-11IEC	6.7	800	120	120	60	C	47
ABCE1100-11IEC	9.2	1100	120	120	60	D	73
ABCE1440-11IEC	10.6	1440	120	120	60	D	79

International	Load Current (Amps)	Load Power (VA)	Input Voltage (VAC)	Output Voltage (VAC)	Frequency (Hz)	Case Size	Ship Weight (kg)
ABCE420-22IEC	1.8	420	230	230	50/60	B	14.5
ABCE600-22IEC	2.6	600	230	230	50/60	C	18.5
ABCE800-22IEC	3.5	800	230	230	50/60	C	21.5
ABCE1100-22IEC	4.8	1100	230	230	50/60	D	33.5
ABCE1440-22IEC	6.3	1440	230	230	50/60	D	36.0

**Case Dimensions** (H x W x D) - in. (mm.):  
 B Case - 6.60 x 5.50 x 17.75 (168 x 140 x 451)  
 C Case - 8.00 x 5.80 x 17.50 (203 x 147 x 445)  
 D Case - 8.75 x 8.30 x 19.75 (222 x 211 x 502)

# POWERVER

## Security One Rackmount UPM

**POWERVER UNINTERRUPTIBLE POWER MANAGER:  
WHAT A DIFFERENCE A LETTER MAKES.**



### Achieving a power conditioning solution in a rackmount enclosure

If you think a UPS is the ultimate in power protection, we've got some news for you: Our Security One Rackmount UPM, or Uninterruptible Power Manager, performs functions your UPS never dreamed of. These rackmount UPMs are designed in a convenient 3U rackmount form factor.

The Security One Rackmount UPM incorporates a low impedance isolation transformer, noise filter and surge diverter to assure power disturbances will be limited to less than 10 volts normal mode and less than 0.5 volts (common-mode) neutral-to-ground allowing the UPM to deliver completely conditioned power, something few UPS products can do.

All North American models have UL and cUL listings. International models are safety-agency listed and carry the CE mark.

- Product sizes range from 600 VA to 1440 VA
- Low impedance isolation transformer and line interactive operation
- True sine-wave output
- User hot-swappable battery
- Meets FCC Class A (Class B Optional)
- Meets NEMA, FAA and DOT guidelines for transportation of UPS batteries
- 19" rackmount design
- Five-year warranty on electronics and two-year warranty on battery

North American	Load Power (VA/Watts)	Input Voltage (VAC)	Output Voltage (VAC)	Frequency (Hz)	Size (in.) (H x W x D)	Ship Weight (lb)
<b>ABCE600-11R</b>	600/420	120	120	60	5.20 (3U) x 19.00 x 19.51	62
<b>ABCE800-11R</b>	800/560	120	120	60	5.20 (3U) x 19.00 x 19.51	67
<b>ABCE1100-11R</b>	1100/770	120	120	60	5.20 (3U) x 19.00 x 19.51	80
<b>ABCE1440-11R</b>	1440/1008	120	120	60	5.20 (3U) x 19.00 x 19.51	94

International	Load Power (VA/Watts)	Input Voltage (VAC)	Output Voltage (VAC)	Frequency (Hz)	Size (in.) (H x W x D)	Ship Weight (kg)
<b>ABCE600-22R</b>	600/420	230	230	50/60	132.10 (3U) x 482.60 x 495.55	28
<b>ABCE800-22R</b>	800/560	230	230	50/60	132.10 (3U) x 482.60 x 495.55	31
<b>ABCE1100-22R</b>	1100/770	230	230	50/60	132.10 (3U) x 482.60 x 495.55	37
<b>ABCE1440-22R</b>	1440/1008	230	230	50/60	132.10 (3U) x 482.60 x 495.55	43

# POWERVAR

## Security One Medical Rackmount (Class A & B) UPM

### POWERVAR UNINTERRUPTIBLE POWER MANAGER: WHAT A DIFFERENCE A LETTER MAKES.



For use with microprocessor-based medical equipment requiring conformance with UL60601 and IEC60601.

If you think a UPS is the ultimate in power protection, we've got some news for you: Our Security One Medical Rackmount UPM, or Uninterruptible Power Manager, performs functions your old UPS never dreamed of. These rackmount UPMs are designed in a convenient 3U rackmount factor form.

For medical systems used in the vicinity of a patient (or anywhere that low leakage current is required), our medical rackmount UPMs are the perfect solution for providing completely conditioned, uninterruptible power.

North American models are listed to UL60601-1 and cUL22.2 No. 60601-1 and are suitable for patient vicinity applications. International models are listed to IEC60601-1 and are CE marked. All models reduce connected equipment leakage current to less than 300  $\mu$ mamps.

- Product sizes range from 600 VA to 1440 VA
- True sine-wave output
- Low impedance isolation transformer and line interactive operation
- FCC Class A and Class B models are available
- Meets NEMA, FAA, and DOT guidelines for transportation of UPS batteries
- 19" rackmount design
- Let through voltage is less than 10 volts normal mode and less than 0.5 volts neutral-to-ground when tested to ANSI/IEEE C62.41
- POWERVAR's five-year warranty (two-year on batteries) on parts and labor provides complete peace of mind



North American	Load Power (VA/Watts)	Input Voltage (VAC)	Output Voltage (VAC)	Size (in.) (H x W x D)	Ship Weight (lb)
ABCE600-11IECR	600/420	120	120	5.20 (3U) x 19.00 x 19.51	62
ABCE800-11IECR	800/560	120	120	5.20 (3U) x 19.00 x 19.51	67
ABCE1100-11IECR	1100/770	120	120	5.20 (3U) x 19.00 x 19.51	80
ABCE1440-11IECR	1440/1008	120	120	5.20 (3U) x 19.00 x 19.51	94

International	Load Power (VA/Watts)	Input Voltage (VAC)	Output Voltage (VAC)	Size (in.) (H x W x D)	Ship Weight (kg)
ABCE600-22IECR	600/420	230	230	132.10 (3U) x 482.60 x 495.55	25.4
ABCE800-22IECR	800/560	230	230	132.10 (3U) x 482.60 x 495.55	27.2
ABCE1100-22IECR	1100/770	230	230	132.10 (3U) x 482.60 x 495.55	32.7
ABCE1440-22IECR	1440/1008	230	230	132.10 (3U) x 482.60 x 495.55	39

# POWERVAR Security Plus Series UPS



## Power protection and reliability for your mission critical application

Over sizing a power protection system can result in higher costs to buy, install and operate. With the Security Plus Series UPS from POWERVAR, you do not have to oversize your equipment. The Security Plus Series is built to handle modern computer loads - systems with high crest factors and high current inrush peripherals - so over sizing is never an issue. In turn saving you money on your power protection equipment investment.

Security Plus offers custom solutions to meet the electrical requirements in today's most diverse environments. You have the ability to custom design the output receptacle panel and your input line cord. These options allow the Security Plus Series to offer quick and easy on-site connection to your equipment.

All models are UL listed and CE marked.

- Product sizes range from 2 kVA to 15 kVA
- Wide input voltage and frequency window provided by the online inverter
- Impressive 0.9 output power factor
- Low impedance isolation transformer
- Low input THDi
- Industry leading overload capabilities
- Diverse input voltage options
- Let through voltage is less than 10 volts normal mode and less than 0.5 volts neutral-to-ground when tested to ANSI/IEEE C62.41
- POWERVAR's three-year warranty (two-year on batteries) on parts and labor provides complete peace of mind



Low Voltage	Load Power (kVA)	Input Voltage (VAC)	Output Voltage (VAC)	Input Plug	Output Receptacles	Frequency (Hz)	Case Size	Ship Weight lb (kg)
ABCDEF2000-11	2.0	100-120	100-120	Option Available	Option Available	50/60	A	310 (130)
ABCDEF3000-11	3.0	100-120	100-120	Option Available	Option Available	50/60	A	389 (175)

High Voltage	Load Power (kVA)	Input Voltage (VAC)	Output Voltage (VAC)	Input Plug	Output Receptacles	Frequency (Hz)	Case Size	Ship Weight lb (kg)
ABCDEF2000-22	2.0	200-240*	200-240*	Option Available	Option Available	50/60	A	316 (142)
ABCDEF3000-22	3.0	200-240*	200-240*	Option Available	Option Available	50/60	A	395 (178)
ABCDEF4000-22	4.0	200-240*	200-240*	Option Available	Option Available	50/60	A	412 (185)
ABCDEF5200-22	5.2	200-240*	200-240*	Option Available	Option Available	50/60	A	443 (200)
ABCDEF6000-22	6.0	200-240*	200-240*	Option Available	Option Available	50/60	A	443 (200)
ABCDEF8000-22	8.0	200-240*	200-240*	Option Available	Option Available	50/60	B	642 (291)
ABCDEF10.0-22	10.0	200-240*	200-240*	Option Available	Option Available	50/60	B	642 (291)
ABCDEF12.0-22	12.0	200-240*	200-240*	Option Available	Option Available	50/60	C	807 (366)
ABCDEF15.0-22	15.0	200-240*	200-240*	Option Available	Option Available	50/60	C	827 (375)

\* 200, 208, 220, 230 & 240 volt solutions.  
\* Contact factory for input and output options.

### Case Dimensions (H x W x D) - in. (mm.):

A Case - 28.90 X 11.80 X 31.91 (735 X 300 X 811)  
B Case - 33.46 X 13.77 X 38.61 (850 x 350 x 981)  
C Case - 42.53 x 15.75 x 44.39 (1080 x 400 x 1128)

# POWERVAR

## Local Area Power Center (LAPC)



Designed for the space limitations of today's small business.

The POWERVAR Local Area Power Center (LAPC) frees up valuable counter space helping you make your Point-of-Sale solution more efficient and profitable.

Antiquated POS power quality blueprints matched an individual UPS system with each cash register, computer, or peripheral to ensure quality uninterruptible power. Valuable business counter space was sacrificed for bulky UPS equipment. Now, POWERVAR has integrated a central UPS system with a single power interface panel to eliminate the need for multiple UPS systems in prime real estate. This technologically advanced design incorporates the UPS system, maintenance bypass system (MBS), and power distribution unit (PDU) all in one compact location away from the customers. POWERVAR's Local Area Power Center is this specialized product.

- 1440 VA and 3000 VA models available
- True sine-wave output
- Low impedance isolation transformer
- Let through voltage is less than 10 volts normal mode and less than 0.5 volts neutral-to-ground when tested to ANSI/IEEE C62.41
- Manual make before break transfer switch provides redundant power for those instances when the UPM needs to be removed for maintenance or battery replacement
- Integrated mounting shelf for convenient installation
- POWERVAR's five-year warranty on electronics, two-year warranty on batteries

North American	Load Power (VA)	Input Voltage (VAC)	Output Voltage (VAC)	Frequency (Hz)	Case Size	Ship Weight (lb)
LAPC 1440	1440	120	120	60	Consult Factory	Consult Factory
LAPC 3.0	3000	120	120	60		

**Case Dimensions** (H x W x D) - in. (mm.):  
 D Case - 5.60 x 11.15 x 16.10 (142 x 283 x 409)  
 E Case - 7.50 x 16.20 x 12.75 (193 x 289 x 323)

# POWERVER 3200 Series Three-Phase UPS

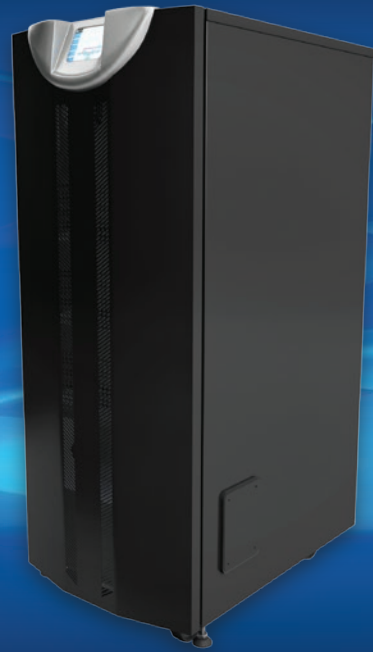

Where power quality is a big problem,  
your solution does not have to be.

The 3200 Series Three-Phase Uninterruptible Power Supply (UPS) is designed for small data centers and critical load applications. POWERVER 3200 Series' reliability and superior design has the smallest footprint in the industry which translates to more data center space for additional computer racks. The 3200 Series inrush current capability to withstand up to 300% of rated load.

All models are UL and cUL listed.

- Product sizes range from 10 kVA to 40 kVA
- The most advanced IGBT technology, wide input voltage range
- High efficiency rate, up to 93%
- Front and top access for serviceability
- Incorporates paralleling of units (up to four) for redundancy or capacity
- Integrated SNMP network card and Modbus ports to remotely monitor and manage the UPS system
- Two-year warranty (includes batteries)

kVA Size	kW	Internal Runtime	Input Voltage (VAC)	Output Voltage (VAC)	Size (in.) (H x W x D)	Ship Weight (lb)
10 kVA	9 kW	10 minutes	208	208/120	48 x 18 x 34	600
20 kVA	18 kW	7 minutes	208	208/120	48 x 18 x 34	700
30 kVA	27 kW	9 minutes	208	208/120	60 x 23 x 35	1,050
40 kVA	36 kW	6 minutes	208	208/120	60 x 23 x 35	1,050

#### Accessories:

- Matching Transformer Cabinets
- Matching Battery Cabinets
- Matching Maintenance Bypass System Cabinets
- DC Disconnects
- Wall-mounted external Maintenance Bypass Systems
- Remote Monitoring Panel (RMP)

# POWERVAR ONePlus™ Series UPS



Engineered to satisfy demanding applications.

The ONePlus Series UPS features line interactive technology with a low impedance isolation transformer. The ONePlus Series is the UPS of choice for supporting critical applications until a managed shutdown is complete or power is restored.

The ONePlus Series features a low impedance isolation transformer and ONEGround technology to protect against all power viruses and ground loops, which makes it a perfect fit for the Point-of-Sale (POS) industry. Featuring both USB and serial communications ports, ONePlus supports basic to the most advanced communications. MopUPS Express Software is bundled with each system and is ideal for data logging, alarm notifications and controlled shutdowns.

All models are UL and cUL listed and CE marked.

- Product sizes range from 250 VA to 1000 VA
- Low impedance isolation transformer
- Let through voltage is less than 10 volts normal mode and less than 0.5 volts neutral-to-ground when tested to ANSI/IEEE C62.41
- True sine-wave output
- Front access user replaceable batteries
- Extended run battery packs available
- Includes MopUPS Express Communications Software
- POWERVAR's five-year product warranty (two-years on the batteries)



North American	Load Current (Amps)	Load Power (VA)	Input Voltage (VAC)	Output Voltage (VAC)	Frequency (Hz)	Case Size	Ship Weight (lb)
ONE254AG-SE	2.00	250	120	120	60	A	28.0
ONE404AG-SE	3.33	400	120	120	60	B	28.6
ONE604AG-SE	5.00	600	120	120	60	C	57.0
ONE1004AG-SE	8.33	1000	120	120	60	C	63.0

International	Load Current (Amps)	Load Power (VA)	Input Voltage (VAC)	Output Voltage (VAC)	Frequency (Hz)	Case Size	Ship Weight (kg)
ONE254AG-SE	1.08	250	230	230	50/60	A	12.7
ONE404AG-SE	1.74	400	230	230	50/60	B	13.0
ONE604AG-SE	2.60	600	230	230	50/60	C	25.9
ONE1004AG-SE	4.35	1000	230	230	50/60	C	28.5

**Case Dimensions** (H x W x D) - in. (mm.):  
 A Case - 7.1 x 5.5 x 14.3 (180 x 140 x 363)  
 B Case - 7.1 x 5.5 x 15.4 (180 x 140 x 391)  
 C Case - 9.3 x 7.1 x 15.0 (236 x 180 x 381)



# POWERVER ON Series Universal Mount



## Tower or Rackmount Solution in One.

The On Series Universal Mount UPS provides a high performance power quality solution with universal mounting capability and scalable runtime. It has a built-in low impedance isolation transformer to eliminate electrical noise, ensuring connected electrical equipment is unaffected by the electrical environment.

The ON Series Universal Mount UPS features scalable runtime, advanced communications, MopUPS Professional Software and a low impedance isolation transformer for premium power conditioning and battery backup protection. These UPS systems are suitable for 19" rackmount applications or vertical or horizontal floor mount configurations. A 23" rackmount option and SNMP adapter options are available.

All models are UL and cUL listed and CE marked.

- Product sizes range from 700 VA to 3000 VA
- Low impedance isolation transformer
- Let through voltage is less than 10 volts normal mode and less than 0.5 volts neutral-to-ground when tested to ANSI/IEEE C62.41
- Configurable as tower or 19" rack
- Line up and match battery cabinets
- Front access user replaceable batteries
- POWERVER's five-year product warranty (two-years on the batteries)

North American	Load Current (Amps)	Load Power (VA)	Input Voltage (VAC)	Output Voltage (VAC)	Frequency (Hz)	Case Size	Ship Weight (lb)
<b>ON700XAU-SN</b>	5.80	700	120	120	60	A	65
<b>ON1000XAU-SN</b>	8.30	1000	120	120	60	A	65
<b>ON1500XAU-SN</b>	12.00	1440	120	120	60	A	71
<b>ON2000XAU-SN</b>	16.00	1920	120	120	60	B	114
<b>ON3000XAU-30SN1</b>	19.40	3000	208/230	208/230	60	B	143

International	Load Current (Amps)	Load Power (VA)	Input Voltage (VAC)	Output Voltage (VAC)	Frequency (Hz)	Case Size	Ship Weight (kg)
<b>ON700XIU-SN</b>	3.00	700	230	230	50/60	A	30
<b>ON1000XIU-SN</b>	4.35	1000	230	230	50/60	A	30
<b>ON1500XIU-SN</b>	6.26	1440	230	230	50/60	A	32
<b>ON2000XIU-SN</b>	8.70	2000	230	230	50/60	B	52

**Case Dimensions** (H x W x D) - in. (mm.):  
 A Case - 3.5 x 17.25 x 19.5 (90 x 440 x 500)  
 B Case - 7.0 x 17.25 x 19.5 (180 x 440 x 500)

# POWERVER

## Sinergy S II Series UPS



### Engineered to satisfy demanding applications

Sinergy S II Series UPS is a single-phase, online double conversion UPS. Universal rack/tower design with hot-swappable internal batteries. The extended runtime capability allows backup power protection for up to 4 hours.

The Sinergy S II Series UPS offers a high degree of protection for all your sensitive equipment. Ideal for applications including advanced computer peripherals, telecom electronics, datacenters, advanced control systems and VoIP | PBX systems. MopUPS Express Software is bundled with each system and is ideal for data logging, alarm notifications and controlled shutdowns.

All models are UL and cUL listed and CE marked.

- Product sizes range from 700 VA to 3000 VA
- Online system with true sine-wave output
- Controllable receptacles
- Configurable as tower or 19" rack
- Line up and match extended battery packs available
- Safety approvals: UL, cUL and CE
- POWERVER's two-year product warranty



North American	Load Current (Amps)	Load Power (VA)	Input Voltage (VAC)	Output Voltage (VAC)	Frequency (Hz)	Dimensions (HxWxD)
<b>S0K7XAU</b>	5.8	700	120	120	50/60	3.4 x 17.2 x 19.2
<b>S1K0XAU</b>	8.3	1000	120	120	50/60	3.4 x 17.2 x 19.2
<b>S1K5XAU</b>	12.5	1500	120	120	50/60	3.4 x 17.2 x 19.2
<b>S2K0XAU</b>	16.7	2000	120	120	50/60	3.4 x 17.2 x 26.2
<b>S3K0XAU</b>	25.0	3000	120	120	50/60	3.4 x 17.2 x 26.2

International	Load Current (Amps)	Load Power (VA)	Input Voltage (VAC)	Output Voltage (VAC)	Frequency (Hz)	Dimensions (HxWxD)
<b>S2K0XHU</b>	9.6	2000	208/220/230/240	208/220/230/240	50/60	3.4 x 17.2 x 26.2
<b>S3K0XHU</b>	14.0	3000	208/220/230/240	208/220/230/240	50/60	3.4 x 17.2 x 26.2

## Why POWERVAR?

- Microprocessor-based systems require power protection solutions which include a low impedance isolation transformer, noise filter and surge diverter.
  - Surge diverters and noise filters, when used alone, create the very types of disruptive power disturbances that lead to downtime, reliability issues, and financial losses.
  - When runtime issues dictate the use of a UPS, the UPS should have a true sinewave design – not square wave, rectangular wave, pseudo-sinewave, PWM, etc.
  - Customers prefer to understand the solutions they are buying; POWERVAR's ABCs of Power Conditioning is best positioned to explain it to them.
  - Customers prefer solutions that actually work, show a return on investment and prefer to buy from companies that sell them.
  - Our power protection solutions are only as valuable as the service, support, and expertise that back them up.

If you want to avoid all unnecessary costs and drive bottom-line profits you need to **ELIMINATE THE POWER VARIABLE**. Whatever your business or profession, equipment that crashes can cause real problems for your entire operation. Damaged or compromised components, disrupted processes, and lack of reliability all add up to frustration, broken schedules and costly downtime.

### POWERVAR Solutions provide

- Proven Technology
- Service Call Reduction
- Builds OEM Customer Loyalty
- Increased Profitability and ROI
- Unparalleled Service and Support

## Manufacturing locally and shipping globally – POWERVAR is Worldwide

Getting conditioned, quality power isn't strictly a North American challenge. Overseas, the quality of electrical power can vary dramatically from place to place.

It's a global economy and that's why POWERVAR manufactures power quality solutions for both North American and international power systems.

POWERVAR is a global provider of power management solutions, headquartered in Waukegan, Illinois, with international sales and distribution offices in Swindon, United Kingdom, Toronto, Canada, Mexico City, Mexico and Paderborn, Germany. All POWERVAR solutions incorporate a high energy surge diverter, a noise filter, and a low impedance isolation transformer. Together these components prevent power disturbances from destroying, degrading or disrupting the point of sales system's operation.

Every piece of electronic equipment in the world works better and more dependably when it's protected from spikes, blackouts, electrical noise, common-mode voltage and other power protection challenges. That's why POWERVAR builds power solutions for virtually every place on earth.

# WE FOCUS ON QUALITY... AND WE DELIVER IT!

All of us at POWERVAR — in the field and at North American headquarters in Waukegan, Illinois; in the U.K., Europe, Canada, Latin America, Asia, and throughout the world – are absolutely dedicated to designing, producing and offering you the finest-quality products possible . . . then backing them with exceptional customer service. It's more than a framed mission statement hanging on the wall — it's an individual commitment from each of us to you.

This dedication to quality shows in our extensive research and development, which has resulted in numerous industry-leading, standard-setting new product innovations (as you can see from reading through this product guide).

And it's abundantly clear in the quality of our people. They're experienced, educated and professionally dedicated to helping you obtain exactly the power protection solutions you need.

*Exactly.*



**American address:**

POWERVAR, INC.  
1450 Lakeside Drive  
Waukegan, IL 60085  
1-800-369-7179  
(P) 847-596-7000  
(F) 847-596-7100



**Canadian address:**

POWERVAR Canada  
700 Finley Avenue, Unit 3  
Ajax, Ontario L1S 3Z2  
(P) 905-239-9284



**International Address:**

POWERVAR, Ltd.  
Unit 5, Birch-Kembrey Park  
Swindon, Wilts SN2 8UU UK  
(P) +44 1793 553980  
(F) +44 1793 535350



**Mexican address:**

POWERVAR Mexico,  
S.A. DE C.V.  
Camino a la Montana  
No. 178-101 & PB4  
Fracc. Industrial La Perla,  
53340 Naucalpan,  
Edo. De Mexico

[WWW.POWERVAR.COM](http://WWW.POWERVAR.COM) | [info@POWERVAR.COM](mailto:info@POWERVAR.COM)

